



PROJECT

CATALOG #

TYPE

NOTES

WS Up Light

STANDARD

Designed with rounded, minimalist features and durable die-cast aluminum, the versatile WS wall wash is the perfect addition to any lighting design.

Quick Facts

- Soft wash and clean transitions
- Die-cast aluminum
- Two-layer marine-grade anodization and TGIC powder coat finish
- G4 bi-pin lamp
- Silicone-encapsulated COB LED
- Compatible with Luxor® technology (Cubes only)
- Input voltage: 10-15V

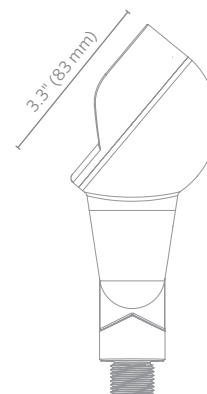
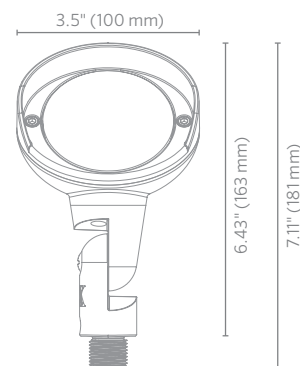

WS Up Light SPECIFICATIONS

Output	LED20W	LED35W
Halogen Lumen Output Equivalent	20W	35W
Total Lumens	50	85
Input Voltage	10 to 15V	10 to 15V
VA Total (Use this number to size the transformer)	1.7	2.6
Watts Used	1.6	2.4
Lumens per Watt (Efficacy)	42	37
CRI (Ra)	84	86
Center Beam Candlepower (CBCP)	27	31
CCT	2,700K	2,700K
Beam Angle	90°	85°
Dimming	Phase*	Phase*
Luxor Compatibility		
ZD Option	Use Luxor Cube (LCM-LV)	Use Luxor Cube (LCM-LV)
Minimum Rated Life (L70)	33,000 hrs	33,000 hrs

* For optimal performance, use a trailing-edge, phase-cut dimmer.

FX Luminaire

FX Luminaire is an industry-leading manufacturer of landscape and architectural lighting products with a focus on the advancement of LED technology and digital lighting control with zoning, dimming, and color adjustment capabilities. We offer a full spectrum of highly efficient lighting fixtures that can be utilized to create elegant, cutting-edge landscape lighting systems for commercial or residential applications. Our products are available exclusively via our extensive professional distributor network.

Materials

Die-cast A380 aluminum body and shroud with stainless steel fasteners.

Lamp

G4 lamp base. Preinstalled G4 LED lamp option offers a warm 2,700K color temperature with a minimum rated life (L70) of 33,000 hours.

Socket

Socket contains MoistureBlock™ technology, preventing moisture from wicking up into sealed areas of the luminaire.

Wiring

18 AWG (1 mm) SPT-1W; 220°F (105°C); 300V; 10' (3 m) length

Power

Input 10-15 VAC/VDC, 50/60 Hz. Remote transformer required (specify separately).

Housing

Die-cast A380 aluminum body with capacity for one T3 lamp.

Knuckle

Die-cast zinc/aluminum alloy knuckle with ½"-14 (15 mm) NPSM threads. Compress and lock features prevent slip after installation. 9° increments adjustability over 220° of vertical alignment.

Lens

Tempered glass lens with shock resistance and high tolerance for thermal expansion and stress.

Glare Control

Die-cast A380 aluminum shroud with cutoff angled at 45° and 1" (25 mm) length.

Finish

Two-layer protection of sulfuric acid anodization and polyester TGIC powder coat, providing superior outdoor weathering in all conditions. Tested to ASTM standards.

Weight

2.2 lbs. (1 kg)

Hardware

Stainless steel machine screws

Ambient Operating Temperature

0°F to 140°F (-18°C to 60°C)

Control

Luxor ZD or Luxor ZDC utilizes Luxor technology to zone luminaires in up to 250 groups, dim each group in 1% increments between 0% and 100%, or change to one of 30,000 colors with RGBW LEDs. Add the Luxor Cube (LCM-LV) to this fixture to add zoning and dimming capabilities with the Luxor controller.

Sustainability

Innovation meets conservation in the design and manufacturing of our products. Where we can, we use recycled materials while maintaining superior functionality. Our LED products provide high-quality light at optimal energy efficiency, lifespan, and durability.

Installation Requirements

Designed for installation in the upward direction only.

Warranty

10-year limited warranty















Manufacturing

ISO 9001:2015 certified facility

Listings



















WS Up Light ORDERING INFORMATION

Fixture	Output	Finish															
WS*	LED35W	<table border="0"> <tr> <td>■ BZ Bronze Metallic</td> <td>■ FB Black</td> <td></td> </tr> <tr> <td>■ SB Sedona Brown</td> <td>■ WI Weathered Iron</td> <td></td> </tr> <tr> <td>■ DG Desert Granite</td> <td>■ SV Silver</td> <td></td> </tr> <tr> <td>■ AL Almond</td> <td>■ FW Flat White</td> <td></td> </tr> <tr> <td>■ WG White Gloss</td> <td></td> <td></td> </tr> </table>	■ BZ Bronze Metallic	■ FB Black		■ SB Sedona Brown	■ WI Weathered Iron		■ DG Desert Granite	■ SV Silver		■ AL Almond	■ FW Flat White		■ WG White Gloss		
		■ BZ Bronze Metallic	■ FB Black														
		■ SB Sedona Brown	■ WI Weathered Iron														
		■ DG Desert Granite	■ SV Silver														
		■ AL Almond	■ FW Flat White														
■ WG White Gloss																	

EXAMPLE FIXTURE CONFIGURATION: WS-LED35W-BZ
* Ships with Super Slot Spike



MOUNTING OPTIONS: Specify Separately			COUPLING OPTIONS: Specify Separately		
Mounts	Catalog No.		Couplings	Code	
■ SUPER SLOT SPIKE 2.5" (64 mm) x 10" (254 mm)	753900		■ STRAIGHT 1.3" (32 mm) x 2.0" (51 mm)	COUP-XX*	
■ LONG SLOT SPIKE 2.5" (64 mm) x 12" (305 mm)	250015840000		■ 90° ELBOW 1.3" (32 mm) x 2.0" (51 mm)	ELBW-050-XX*	
■ SUPER J-BOX 2.5" (64 mm) x 12" (305 mm)	SJ-XX*		■ T-MOUNT 3.0" (76 mm) x 2.2" (57 mm)	TMNT-050-XX*	
■ POST MOUNT 2.5" (64 mm) x 13" (330 mm)	PM-XX*		RISER OPTIONS: Specify Separately		
■ MINI MOUNT 2.6" (65 mm) x 1.3" (320 mm)	MM-050-XX		■ RISER 0.8" (21 mm) Diameter	YY-R-XX*	
■ GROUND MOUNT 2.7" (67 mm) Diameter	GM-XX*		■ SIGN LIGHT RISER 0.8" (21 mm) Diameter with 45° Inward Curve	YY-R-SL-XX*	
■ VERSABOX 2.2" (57 mm) x 1.5" (39 mm)	VB-050-XX*		*YY = riser height in inches (6" increments between 6" and 36"; 150 mm increments between 150 mm and 900 mm), XX = finish code		
■ MINI J-BOX 3.5" (89 mm) x 1.3" (34 mm)	MJ-050-XX*				
■ TREEBOX 5.4" (138 mm) x 1.9" (49 mm)	TB-XX*				
■ GUTTER MOUNT 4.0" (102 mm) x 4.0" (102 mm)	GM-SS				
■ WALL PLATES 3.4" (85 mm) x 5.1" (129 mm)	WP-1G-050-XX*				
■ WALL PLATES 5.0" (127 mm) Diameter	WP-RD-050-XX*				

WS Up Light PHOTOMETRICS

WS LED20W Illuminance at a Distance

Feet	Center Beam	Beam Width	
		Vertical 80.0°	Horizontal 90.0°
3' (0.9 m)	3.0 fc (30 lx)	5.1' (1.6 m)	6.0' (1.8 m)
6' (1.8 m)	0.8 fc (8 lx)	10.2' (3.2 m)	12.0' (3.7 m)
9' (2.7 m)	0.3 fc (3 lx)	15.3' (4.7 m)	18.0' (5.5 m)
12' (3.7 m)	0.2 fc (2 lx)	20.4' (6.2 m)	24.0' (7.3 m)
15' (4.6 m)	0.1 fc (1 lx)	26.0' (7.9 m)	30.0' (9.1 m)
18' (5.5 m)	0.1 fc (1 lx)	31.0' (9.4 m)	36.0' (11.0 m)

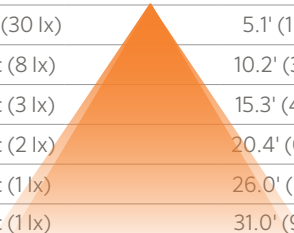

WS LED35W Illuminance at a Distance

Feet	Center Beam	Beam Width	
		Vertical 80.0°	Horizontal 85.0°
3' (0.9 m)	3.3 fc (33 lx)	5.0' (1.5 m)	5.5' (1.7 m)
6' (1.8 m)	0.8 fc (8 lx)	10.1' (3.1 m)	11.0' (3.4 m)
9' (2.7 m)	0.4 fc (4 lx)	15.1' (4.6 m)	16.4' (5.0 m)
12' (3.7 m)	0.2 fc (2 lx)	20.1' (6.1 m)	22.0' (6.7 m)
15' (4.6 m)	0.1 fc (1 lx)	25.2' (7.7 m)	27.3' (8.3 m)
18' (5.5 m)	0.1 fc (1 lx)	30.2' (9.2 m)	33.0' (10.1 m)

